







More Precision

optoNCDT ILR // Laser-optical distance sensors



Fast laser distance sensor for outdoor applications

optoNCDT ILR1171

-  Measuring range up to 125 m, (with reflector 270 m)
-  Laser class 1
-  IP67 Robust design IP67
-  Very high measuring rate for fast applications
-  Optionally with integrated heating for outdoor applications



The optoNCDT ILR1171 is a laser-based distance sensor for non-contact and precise distance and displacement measurements from 0.2 m up to 125 m. The measuring range can be extended to 270 m with a reflector film. The sensor is designed for very large measuring ranges, with and without reflector. Due to the very high measuring rate of the sensor, moving objects can be measured easily. Even in poor visibility conditions, the ILR1171 impresses with its high signal intensity for stable measurements.

Versatile fields of application

The optoNCDT ILR1171 is fitted with an integrated heater for outdoor use. A pilot laser is also integrated for mounting and adjustment. This makes it easier to align the sensor over long distances, for example when monitoring buildings. The RS422 and RS232 interfaces ensure reliable and fast data transmission.

Time-of-flight principle

The sensor operates according to the laser pulse runtime principle and is therefore particularly well suited to applications with large distances. Commissioning of the sensor is straightforward due to a variety of interfaces and easy installation options. The actual measuring range depends on the reflectivity and the surface quality of the object to be measured.

Dimensions:

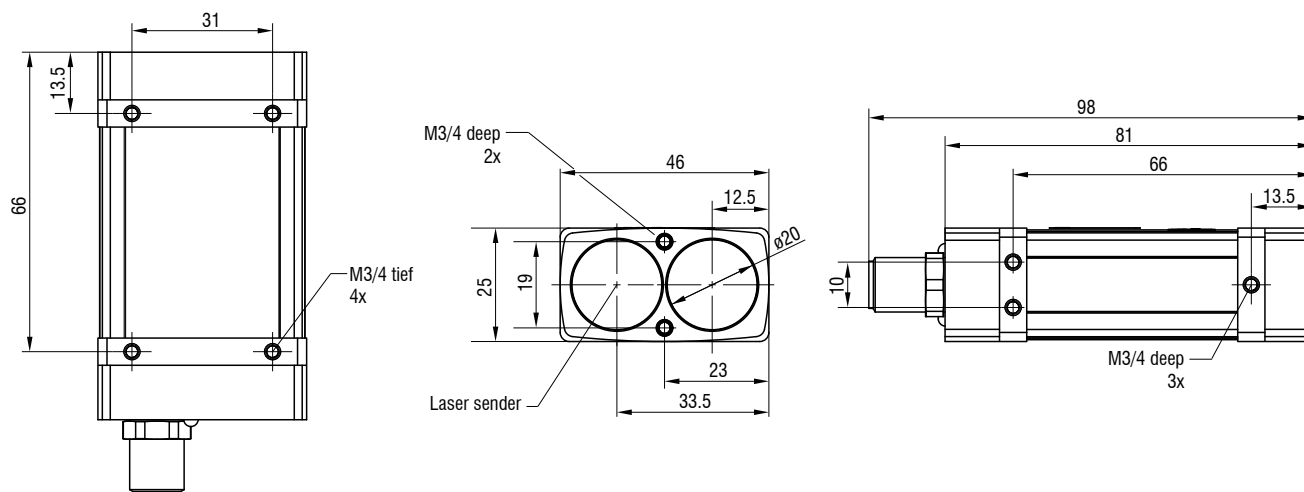

(dimensions in mm, not to scale)

Model		ILR1171-125
Article number		7112027
Measuring range ^[1]	Black 10 %	70 m
	Gray 40 %	100 m
	White 80 %	125 m
	Reflector film ^[2]	270 m
Start of measuring range		0.2 m ^[3]
Measuring rate		40 kHz
Resolution		1 mm
Linearity		< ±60 mm ^[4]
Repeatability ^[5]		<25 mm
Temperature stability		< 20 ppm / K
Light source		Semiconductor laser < 1 mW, 905 nm (red)
Laser class		Class 1 in accordance with IEC 60825-1: 2022-07
Permissible ambient light		50,000 lx
Supply voltage		10 ... 30 VDC
Power consumption		< 3 W (24 V)
Signal input		Trigger
Digital interface		RS232 / RS422
Analog output		4 ... 20 mA (16 bit, freely scalable within the measuring range)
Switching output		Q1 / Q2 (configurable); trigger
Connection		Supply/signal: 12 pin M12 screw/plug connection
Mounting		Mounting holes
Temperature range	Storage	-40 ... +70 °C (non-condensing)
	Operation	-20 ... +60 °C (non-condensing)
Shock (DIN EN 60068-2-29)		30 g / 6 ms in 6 directions, 3 shocks each
Vibration (DIN EN 60068-2-6)		1 g / 10 ... 2000 Hz in 3 axes, 2 cycles each
Protection class (DIN EN 60529)		IP67
Material		Aluminum housing
Weight		approx. 140 g
Control and indicator elements		2x LEDs for power and signal
Special features		Measurement-specific operating modes

^[1] Depends on the reflectivity of the target, ambient light interference and atmospheric conditions

^[2] ILR-RF250 reflector film 250 x 250 mm; art. 7966001

^[3] 0.5 m for measurement with reflector film

^[4] Linearity in the ranges of ≤ 1 m and ≥ 70 m is ±100 mm

^[5] Repeatability in the ranges ≤ 1 m and ≥ 70 m is ±50 mm

Light spot diameter

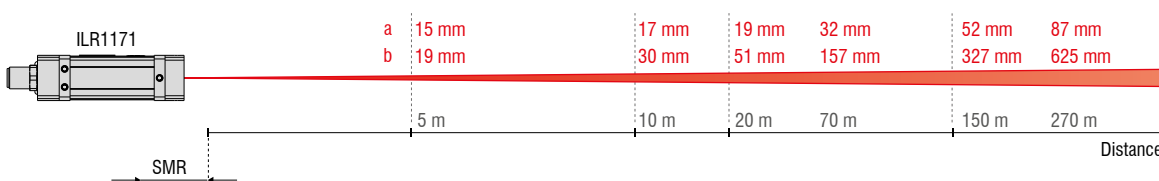

The optoNCDT ILR 1171 sensors use a semiconductor class 1 laser (operating mode) and a semiconductor class 2 laser (setup mode). Devices in these laser classes require no special safety precautions.

Connection possibilities optoNCDT ILR



ILR104x



ILR3800-IO



ILR3800
ILR3800-H



Power supply unit PS2020
(Optional for DIN rail mounting)



ILR1171

Supply and output cables

29011586	PC1040-10	Supply and output cable, 10 m
29011587	PC1040-2	Supply and output cable, 2 m
29011588	PC1040/90-2	Supply and output cable, 2 m
29011589	PC1040-5	Supply and output cable, 5 m
29011590	PC1040/90-5	Supply and output cable, 5 m
29011590	PC1040-10	Supply and output cable, 10 m
29011591	PC1040/90-10	Supply and output cable, 10 m
29011592	PC1040-20	Supply and output cable, 20 m
29011593	PC1040/90-20	Supply and output cable, 20 m

Supply and output cables

29011669	PC3800-5 IO-Link	Supply and output cable, 5 m
29011670	PC3800-10 IO-Link	Supply and output cable, 10 m
29011671	PC3800-15 IO-Link	Supply and output cable, 15 m
29011672	PC3800-20 IO-Link	Supply and output cable, 20 m

Supply and output cables

29011609	PCF3800-30/IF2004	Supply and output cable, 30 m
29011682	PCF3800-100/IF2004	Supply and output cable, 10 m (to connect 4 ILRs to the IF2004, the IF2008-Y adapter cable is required.)
2901528	IF2008-Y adapter cable	

Connection cables

29011624	PCE3800-20/IF2008ETH	Connection cable, 20 m
29011623	PCE3800-10/IF2008ETH	Y-connection cable, 10 m
29011622	PCE3800-10/IF2008ETH	Connection cable, 10 m
29011621	PCE3800-5/IF2008ETH	Connection cable, 5 m
29011620	PCE3800-2/IF2008ETH	Connection cable, 2 m

Supply and output cables

29011737	PC3800-2/DPU	Supply and output cable, 2 m
29011738	PC3800-5/DPU	Supply and output cable, 5 m
29011739	PC3800-10/DPU	Supply and output cable, 10 m

Supply and output cables

29011513	PC3800-2	Supply and output cable, 2 m
29011514	PC3800/90-2	Supply and output cable, 2 m
29011515	PC3800-5	Supply and output cable, 5 m
29011516	PC3800/90-5	Supply and output cable, 5 m
29011517	PC3800-10	Supply and output cable, 10 m
29011518	PC3800/90-10	Supply and output cable, 10 m
29011519	PC3800-20	Supply and output cable, 20 m
29011520	PC3800/90-20	Supply and output cable, 20 m
29011521	PC3800-30	Supply and output cable, 30 m
29011522	PC3800/90-30	Supply and output cable, 30 m

Supply and output cables

29011401	PC1171-2	Supply and output cable, 2 m
29011402	PC1171-5	Supply and output cable, 5 m
29011403	PC1171-10	Supply and output cable, 10 m

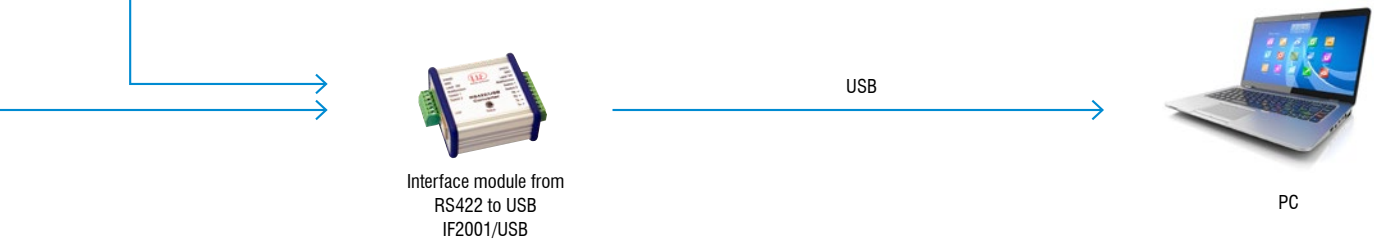
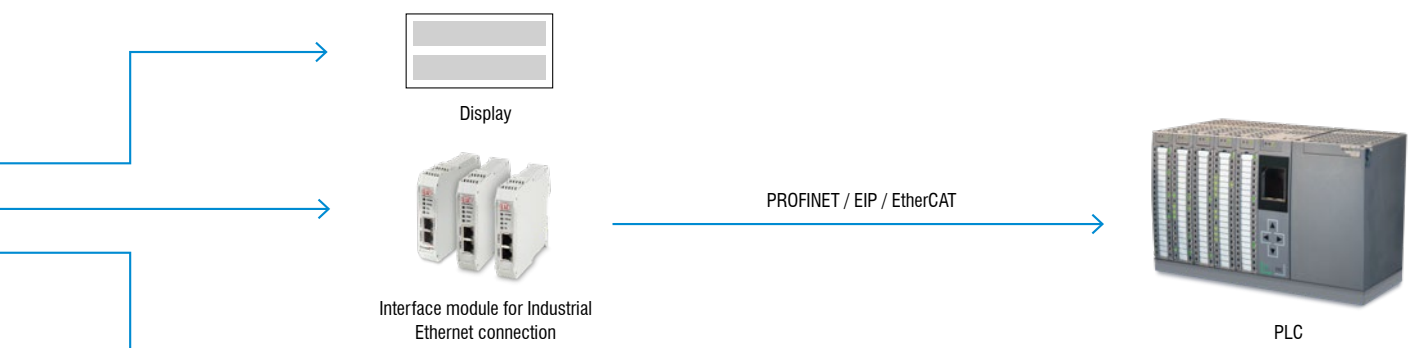
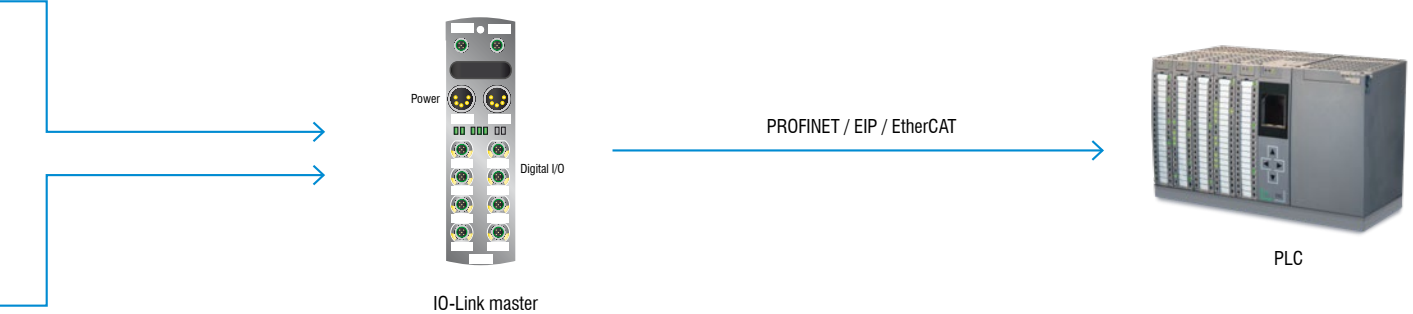

Optional accessories

optoNCDT ILR

Reflector film and target plate

The sensor measures the distance to moving and stationary objects. The reflector film is used to extend the measuring range.

The following aspects should be considered:

- The minimum distance between sensor and reflector film must be observed.
- The laser spot must be centered on the reflector over the entire measuring path.
- The sensor and reflector may be tilted at a maximum angle of 5° to each other.

Reflective films work with targeted retroreflection, whereas a white target plate works with diffuse reflection. With a white target plate, the measuring range can be used up to 100 m – without restrictions in the close range.

Depending on the application, a reflective film or a white target plate can be used:

- optoNCDT ILR1041-x: Reflector film is absolutely necessary to use the measuring range. Measurement is not possible without reflector film.
- optoNCDT ILR1040-x: The use of a white target plate is recommended.

Sensor	Article	Dimensions
optoNCDT ILR104x	Art. no.: 7966001 ILR-RF250 Reflector film	250 x 250 mm
optoNCDT ILR3800	Art. no.: 7966058 ILR-RF210 Reflector film	210 x 297 mm
optoNCDT ILR1171	Art. no.: 7966001 ILR-RF250 Reflector film	250 x 250 mm
optoNCDT ILR	Art.-no.: 7966091 ILR-TB250 White target plate	250 x 250 mm



Protective glass

The sensor can be protected from external influences by using a protective glass.

Sensor	Article	Description
optoNCDT ILR3800	Art. no.: 7966080 ILR-PG3800 Protective glass	Optical glass, with anti-reflection coating and high transmission



Filter glass

Filter glasses enable measurement on highly reflective surfaces. However, this reduces the maximum laser power. Ask your regional sales contact before you use the filter glass.

Sensor	Article	Description
optoNCDT ILR3800	Art.-no.: 7966081 ILR-NDF3800 Filter glass 0.75 Art. no.: 7966082 ILR-NDF3800 Filter glass 0.5 Art. no.: 7966083 ILR-NDF3800 Filter glass 0.9	Optical gray filter



Compressed-air purge system

Particularly suitable for dusty and dirty environments to prevent deposits on the lens. Connection via a 6 mm hose. Recommended pressure: 3 bar.

Sensor	Article	Description
optoNCDT ILR3800	Art.-no.: 7966089 ILR-DLS3800 Compressed-air purge system	For cleaning or permanently keeping the optical path clear.



Mounting plate

The sensor can optionally be mounted using an aluminum plate. This ensures a secure hold and easy alignment of the sensor. Its robust design is suitable even for harsh industrial environments.

Sensor	Article	Description
optoNCDT ILR3800	Art. no.: 7966076 ILR-MP3800	Mounting plate Optional; for easy sensor mounting

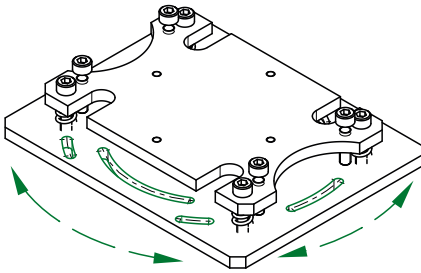

The sensor can optionally be mounted using a mounting plate.

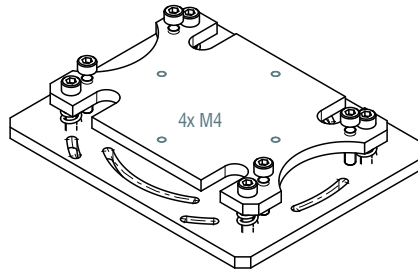

4 mounting threads M4 for sensor mounting, optional: sensor rotated by 90°.

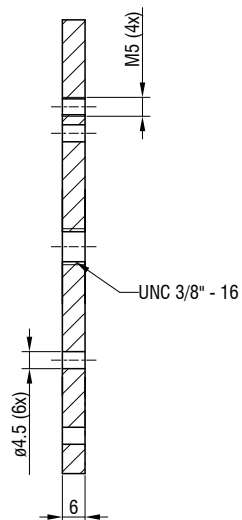
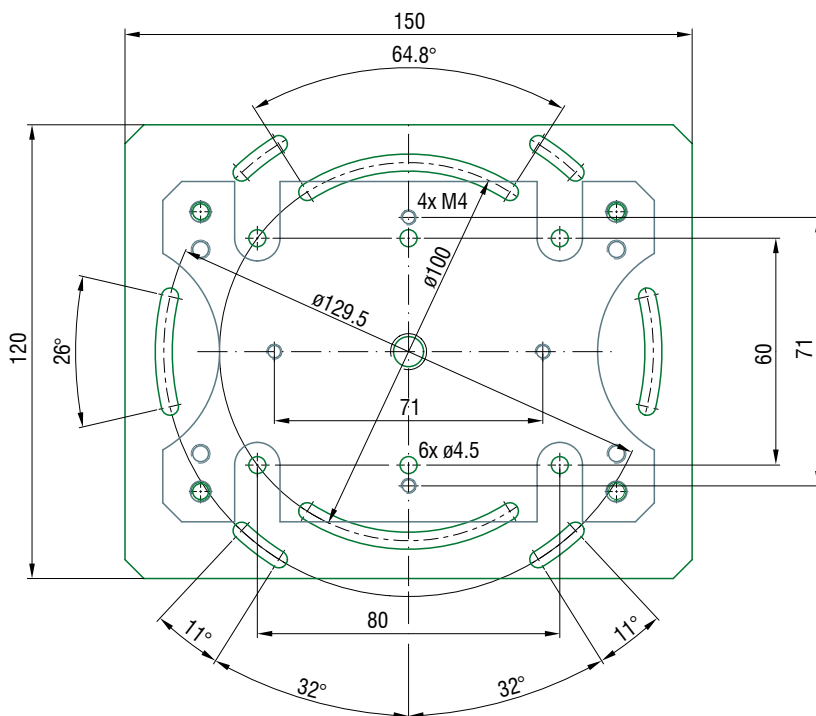
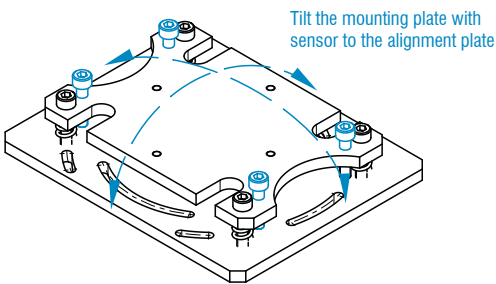

(dimensions in mm, not to scale)

Sensors and Systems from Micro-Epsilon



Sensors and systems for displacement, distance and position



Sensors and measurement devices for non-contact temperature measurement

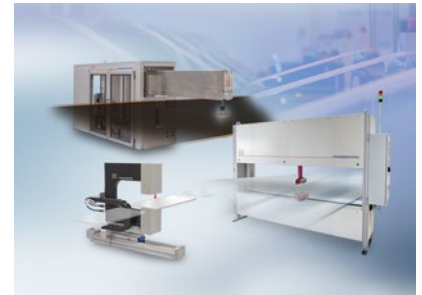

Measuring and inspection systems for metal strips, plastics and rubber



Optical micrometers and fiber optics, measuring and test amplifiers



Color recognition sensors, LED analyzers and inline color spectrometers

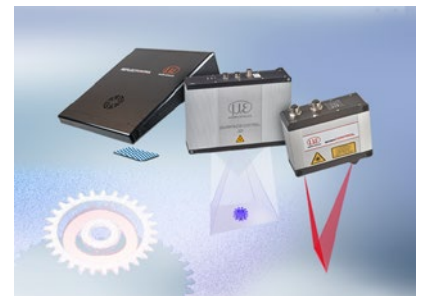

3D measurement technology for dimensional testing and surface inspection